

M-VKT Tischplattendekore



HPL-Hauskollektion



HK F37/023 Buche hell



HK R30019 W Nussbaum



HK R27001 Ahorn



HK F76023 MP Alu



HK U02 Span 140 MP weiß



HK U11102 Kreide W reinweiß



HK U12190 MP flanel



HK U12011 vulkanit



HK U12018 basaltgrau



HK U12188 lichtgrau



HK U16130 MP sandgrau



HK U16184 creme

www.konferenzmoebel.info

Tischplattendekore Nano Tec

Hauskollektion - Uni Dekore

Nano Tec NT - ein **extrem mattes** Nanotech-Material, das raffinierte Ästhetik mit **zukunftsweisender technologischer Leistungsfähigkeit** vereint.

Nano Tec NT ist außerdem **sehr kratz-, abrieb- und scheuerfest** und beständig gegen trockene Hitze. Es ist sehr **schlagfest** und resistent gegen säurehaltige und haushaltsübliche Reiniger. Es hat **antibakterielle Eigenschaften**, wodurch seine Oberfläche hygienisch und leicht zu reinigen ist. Es ist zudem wasserabweisend und schimmelsicher.



HK Nano Tec NT1



HK Nano Tec NT2

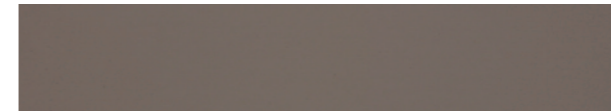

HK Nano Tec NT3

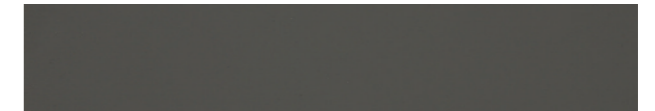

HK Nano Tec NT4

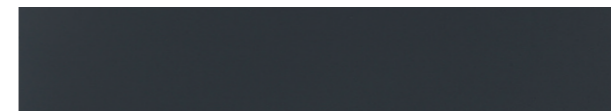

HK Nano Tec NT5

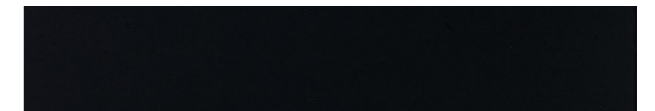

HK Nano Tec NT6

* Schwer entflammbare Ausrüstung auf Anfrage gegen Mehrpreis lieferbar.

Echtholz furnier M-VKT

www.konferenzmoebel.info



HK Eichenfurnier



HK Ahornfurnier



HK Amerikanischer Nussbaum



HK Eschenfurnier

Holzbeiztöne M-VKT



HK F1 natur

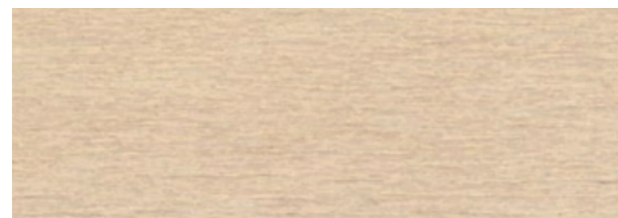

HK F2 Buche ahornfarbig (hell) gebeizt

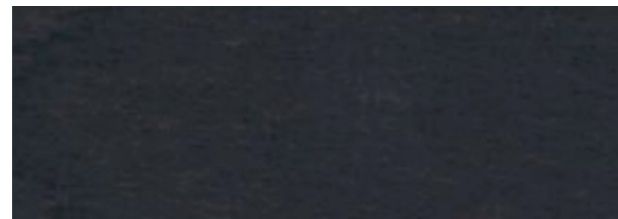

HK F23 dunkelgrau



HK F27 schwarz

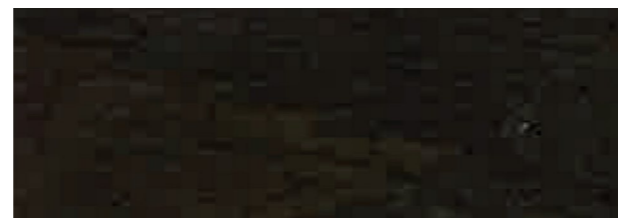

HK F11 dunkelbraun



HK F20 weiß

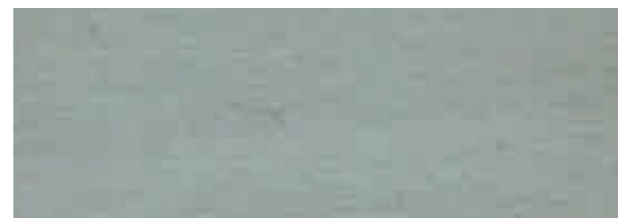

HK F19 hellgrau



HK F28 türkis



HK F22 rot



HK F24 gelb



HK F25 apfelgrün



HK F21 dunkelgrün



HK F29 enzianblau



HK F25 orange

www.konferenzmoebel.info

Tischplattenkantenvarianten M-VKT

Hauskollektion Standard-Kante Holz

Standard-Kanten Kunststoff

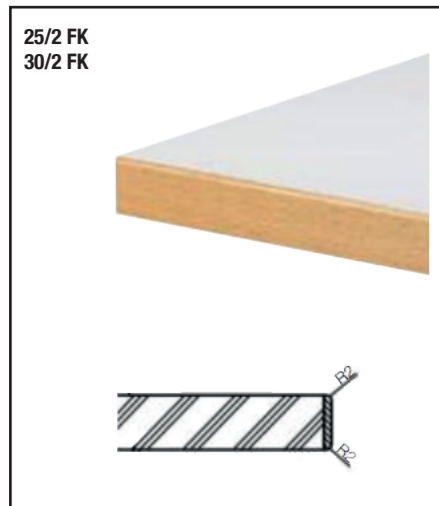

Gerade Standardkante aus Buche 2mm Furnierkante (FK) Echtholz

Tischplatte 25 oder 30mm stark
Oberfläche HPL Tischplattenkante 2
mm stark, oben und unten
gerundet, R 2 mm.

Buchekante optional gebeizt



Hochwertige sehr stark abgeschrägte Tischplatte

Multiplex-Tischplatte (Schichtholz),
30 mm stark, als Trägermaterial, Kante
gefräst, natur lackiert oder gebeizt.

*auf Anfrage.



Kunststoffkante (ABS)

Tischplatte 25 oder 30mm stark
Oberfläche HPL, Tischplattenkante
mit extra schlag-, kratz- und
stoßfester Kunststoffkante 2mm
ABS.

Oben und unten gerundet, R 3 mm.

Gestellfarben M-VKT

www.konferenzmoebel.info



HK Aluminium poliert



HK RAL 9005 schwarz